

Expanded Metal Sheets

شركة المشغولات والمباني المعدنية المحدودة
Steel Building & Structure Co. Ltd.

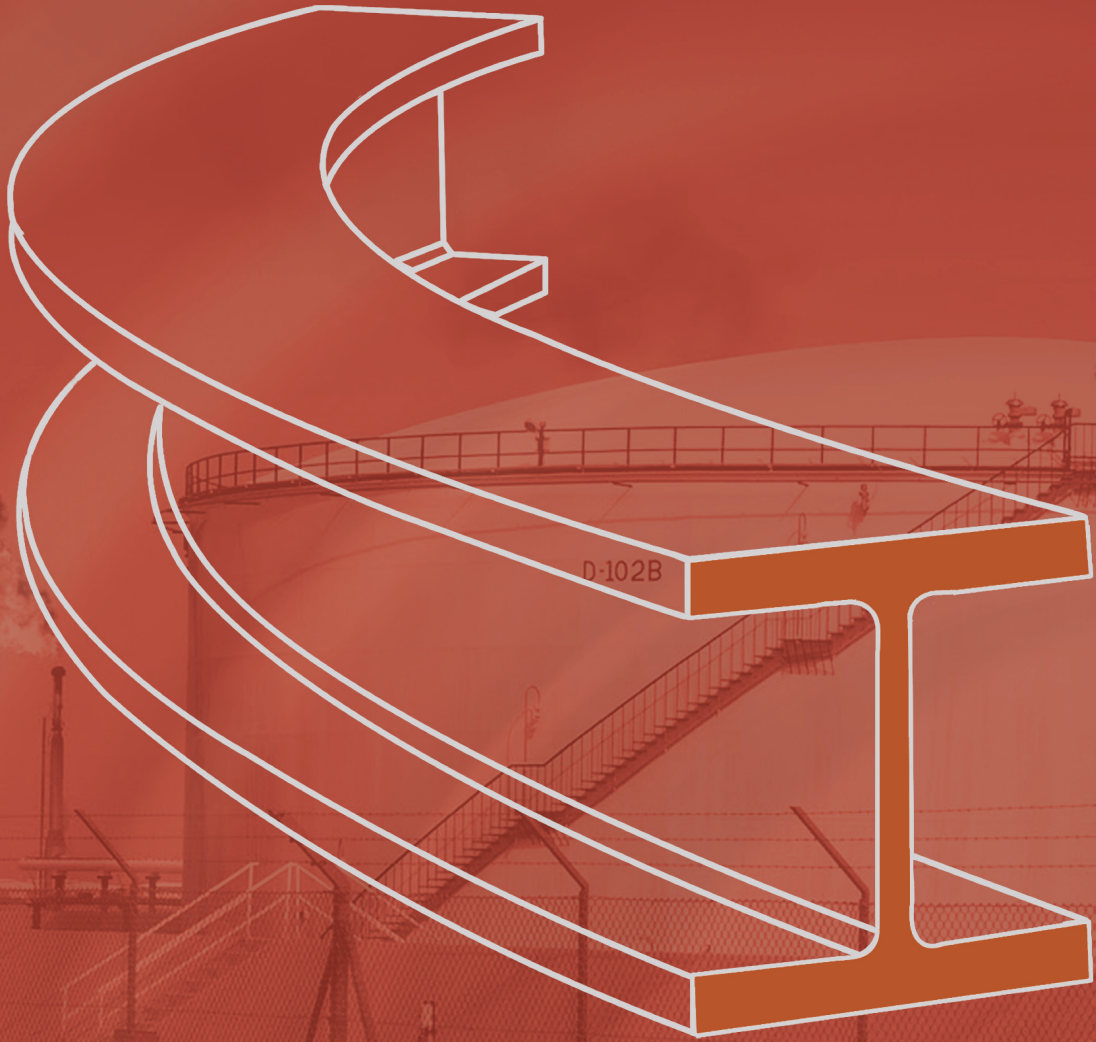

SBSCO Industrial Services

سبسكو للخدمات الصناعية





شركة المشغولات والمباني المعدنية المحدودة STEEL BUILDING & STRUCTURE CO. LTD.

شركة ذات مسؤولية محدودة رأس المال 1.5 مليون ريال سعودي
Dammam 34331 - 4199 - Building No. 7083 - Second Industrial Area
Intersection Street 85 with 150 - Kingdom Of Saudi Arabia
CR. 2050105307 - CC. NO. 175564



+966 13 832 3388 +966 13 832 9933 alabuo@alabuo.co www.alabuo.co



EXPANDED METAL

	Page
Dimensions	120
Module Type Fence	120 - 121
Garage Fittings	122 - 123
Store Room Fittings	124 - 125
Building Fences	126
Dog Kennels	127

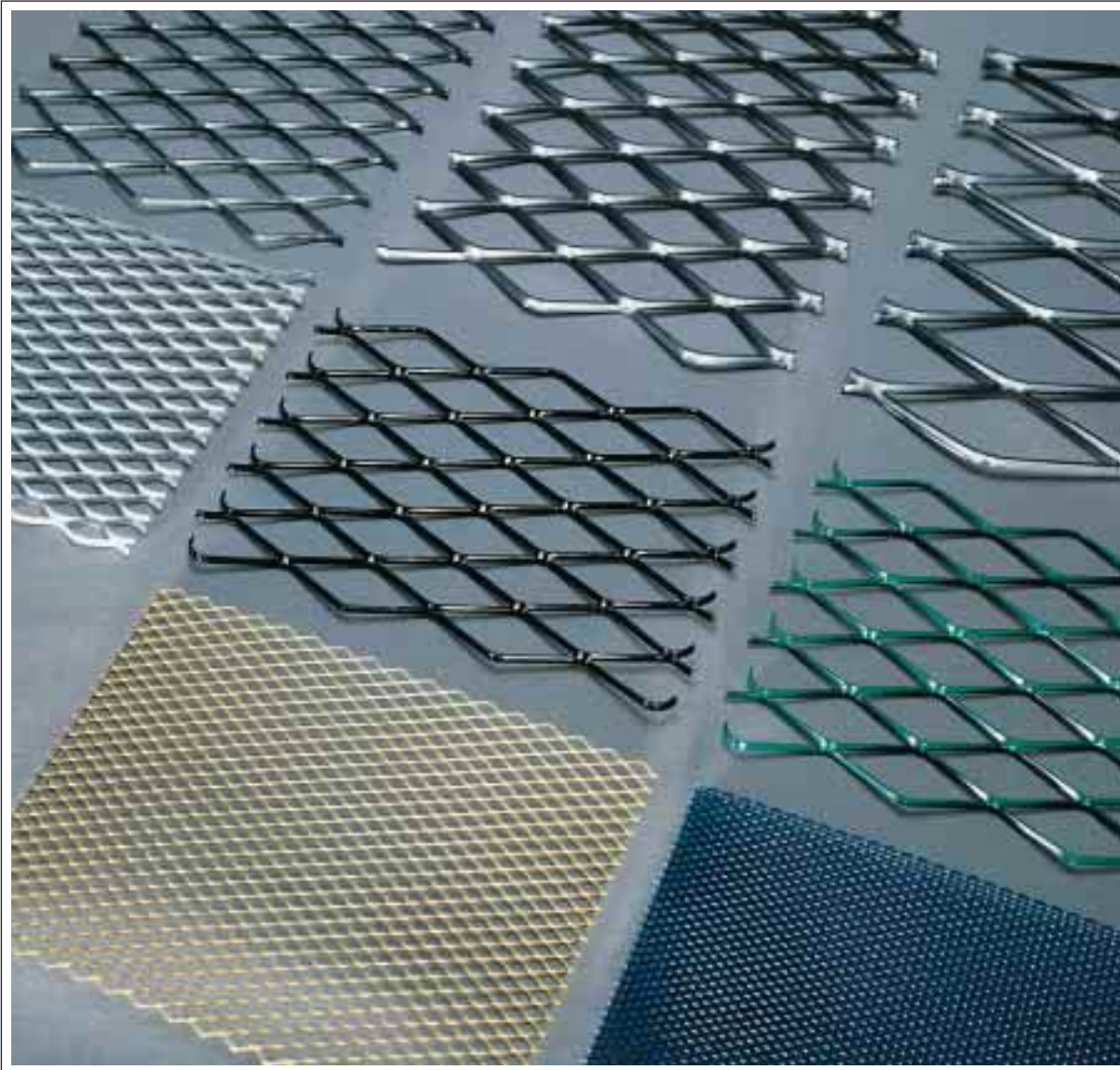

EXPANDED METAL

Expanded Metal is manufactured in a variety of mesh sizes, material dimensions and mat formats. Normally expanded metal is supplied untreated in standard format. Expanded metal is a material with almost unlimited possibilities of application. Expanded metal can thus also be supplied in dimensions, material and mat formats other than standard. You let us know your requirements, we work out the solution.

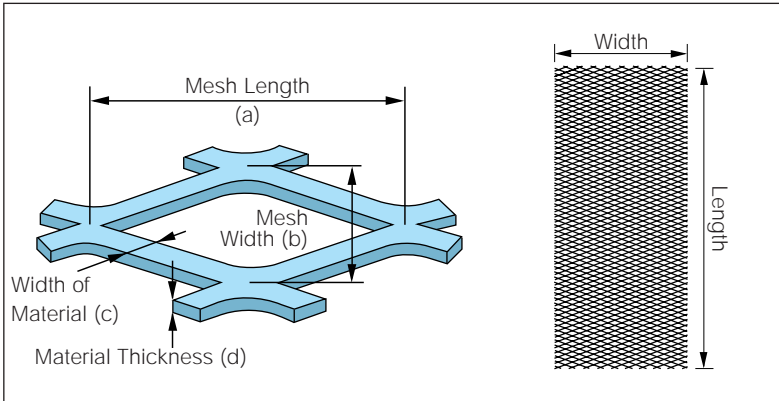

Designation	Mesh Size a x b mm	Width c mm	Thickness d mm	Weight kg/m ²	Format B x L mm
168/1510	16 x 8	1,5	1,0	3,0	1000 x 2400
2010/2015	20 x 10	2,0	1,5	4,8	1000 x 2250
2812/2010	28 x 12	2,0	1,0	2,7	1500 x 1500
2812/2510	28 x 12	2,5	1,0	3,3	1250 x 2500
2812/2515	28 x 12	2,5	1,5	5,0	1500 x 1600
2812/3015	28 x 12	3,0	1,5	6,0	1500 x 2200
4218/2010	42 x 18	2,0	1,0	1,8	1500 x 1800
4218/3015	42 x 18	3,0	1,5	4,0	1000 x 1800
4218/2520	42 x 18	2,5	2,0	4,4	1000 x 2500 1500 x 1700
4218/3030	42 x 18	3,0	3,0	8,0	1000 x 2100
4218/4030	42 x 18	4,0	3,0	10,7	1000 x 2000 1500 x 2000 1500 x 2250
4218/4530	42 x 18	4,5	3,0	12,0	1000 x 2000 1500 x 2000 1200 x 2000
6228/3010	62 x 28	3,0	1,0	1,7	1000 x 2100
6228/2520	62 x 28	2,5	2,0	2,9	1250 x 2500
6228/4030	62 x 28	4,0	3,0	6,9	1000 x 2500
6228/4530	62 x 28	4,5	3,0	7,7	1500 x 1600 1000 x 2500 1500 x 2000
6228/6030	62 x 28	6,0	3,0	10,3	1200 x 2250 1500 x 2250 2000 x 2250
6228/6040	62 x 28	6,0	4,0	13,7	1500 x 2300
7532/3020	75 x 32	3,0	2,0	3,0	1250 x 2250
7532/3030	75 x 32	3,0	3,0	4,5	1000 x 2100
7532/5530	75 x 32	5,5	3,0	8,3	1500 x 2210
11544/2530	115 x 44	2,5	3,0	2,7	1000 x 2200 1250 x 2250 1500 x 2210
11544/4530	115 x 44	4,5	3,0	4,9	1000 x 2100 1500 x 2250
11544/6040	115 x 44	6,0	4,0	8,7	1500 x 2000
11544/9040	115 x 44	9,0	4,0	14,7	1500 x 2500

MODULE TYPE FENCE



The Module Type Fence is constructed of sections of expanded metal with frames of strong cold-rolled profiles. The sections are self-supporting and easily assembled by bolting them together. The sections are supplied in two standard heights and are available with barbed wire on top, if required. Doors and gates are manufactured to the customer requirement. All material is hot dip galvanized as standard.

Mesh Dimensions

Mesh Size (a x b) 115 x 44 mm
 Width of Material (c): 3,0 mm
 Material Thickness (d) 2,5 mm

Stacked Sections

High Fences are stocked in sections with width 1550 mm (building measure 1560 mm) and height 2250 mm.

Low fences with width 1550 and 2000 mm, height 1100 mm.

Doors / Gates

Doors of width 800 mm are standard. Gates and special size doors are manufactured to requirement.

Mounting Fence sections are self-supporting and are bolted together at the bottom and the top (against the anchor foot and the barbed wire retainer, if same is supplied). The mounting is simplified, if 2-3 sections are assembled on the ground and then lifted up and anchored.

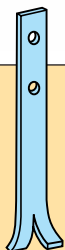
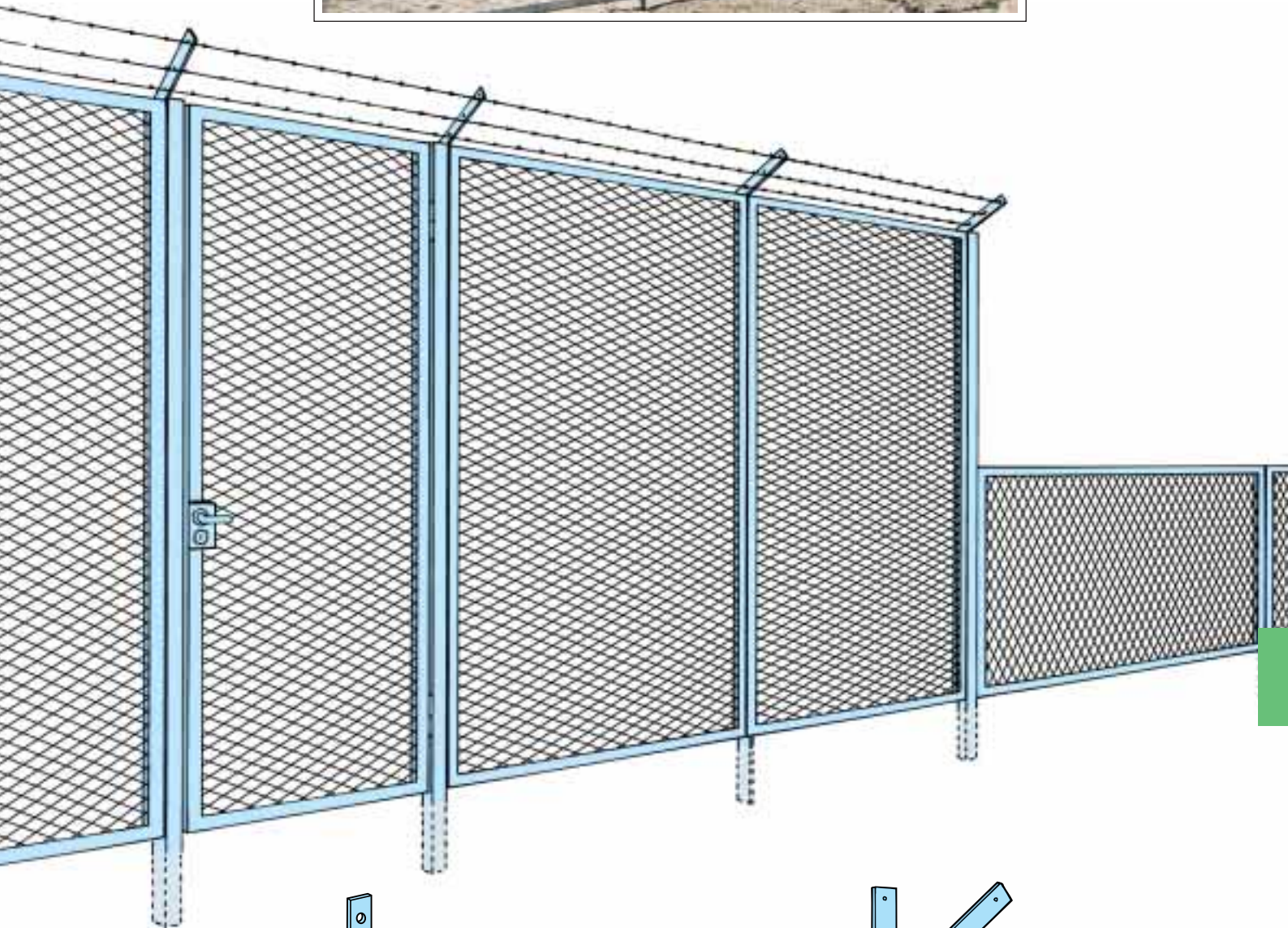

Anchor Foot

Hot dip galvanized anchor foot of flat bar gives fence stable anchoring

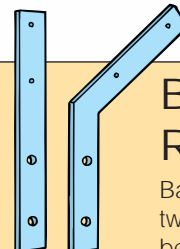

Barbed Wire Retainer

Barbed wire retainer for two wires are mounted between the sections.

GARAGE FITTINGS

Weland Garage Fittings are manufactured from sections of expanded metal with frames of strong cold-rolled steel profiles. The sections are manufactured in optional sizes to fit all sorts of garages irrespective of ceiling height. Each garage has its own sliding gate to be opened against the neighbouring gate. Intermediate walls can be arranged if so required.

Garage Fittings are easily mounted by means of adjustable fixing plates arranged for varying floor inclination and ceiling height.

All material is as standard hot dip galvanized.

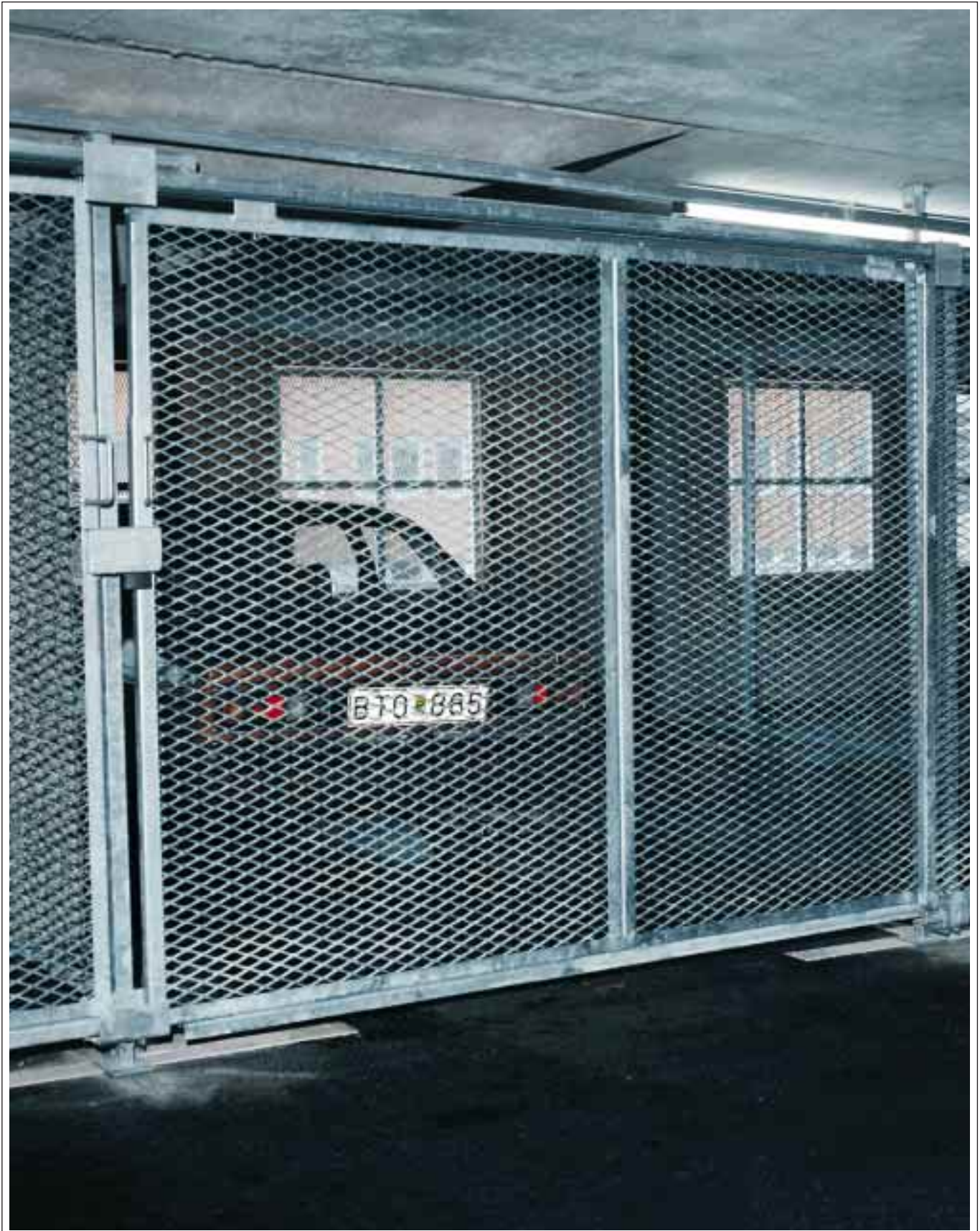

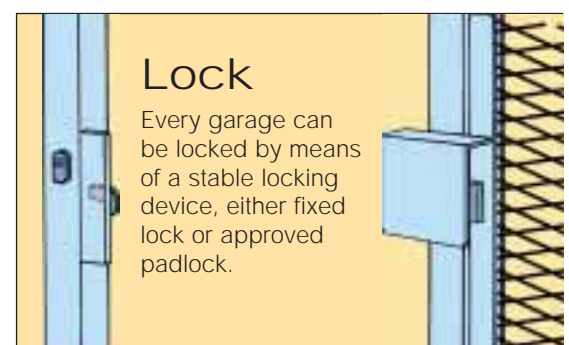
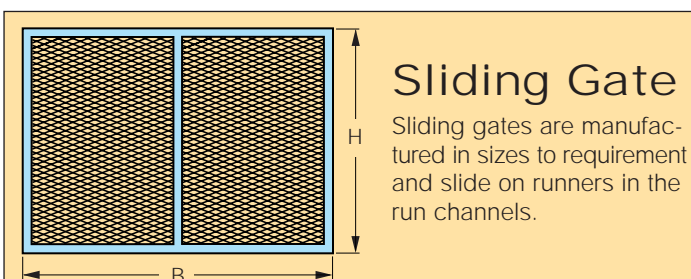
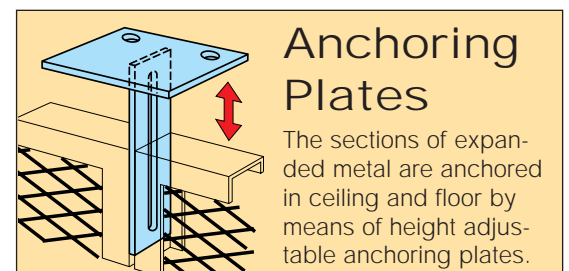
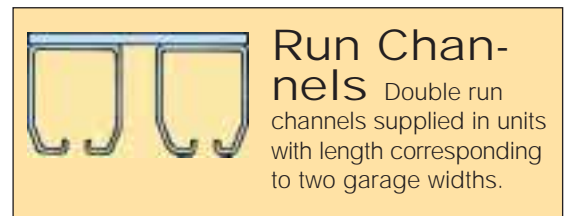
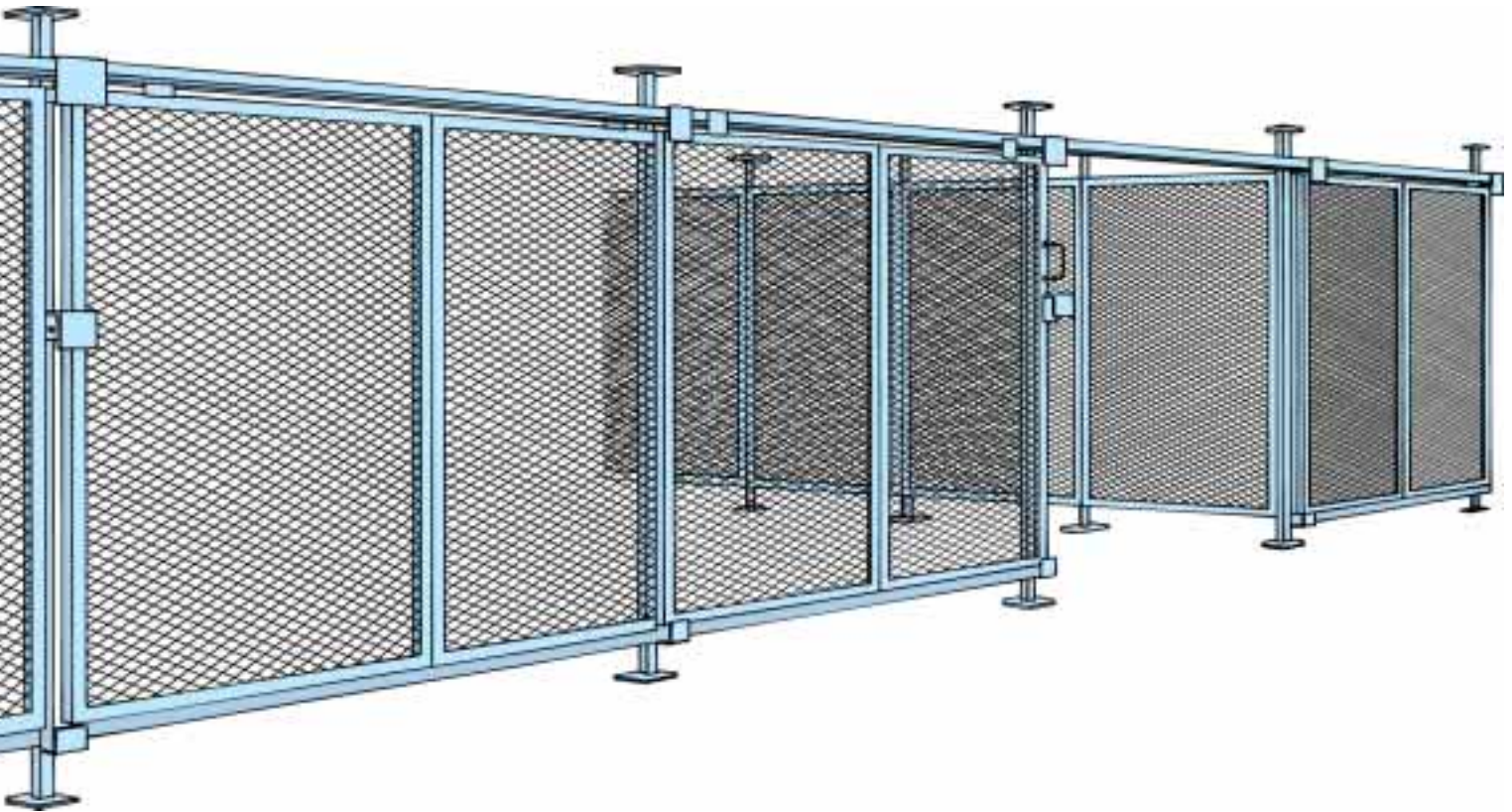

STOREROOM FITTINGS

Storeroom Fittings are intended for cellars and attics in residential houses. They also lend themselves to applications within industrial and building sites.

The system consists of stocked sections of expanded metal with strong self-supporting frames on all sides.

Complete door sections are also in stock. They are all very flexible and easily mounted. Sections other than standard size are manufactured to customer requirement.

As standard all material is hot dip galvanized.



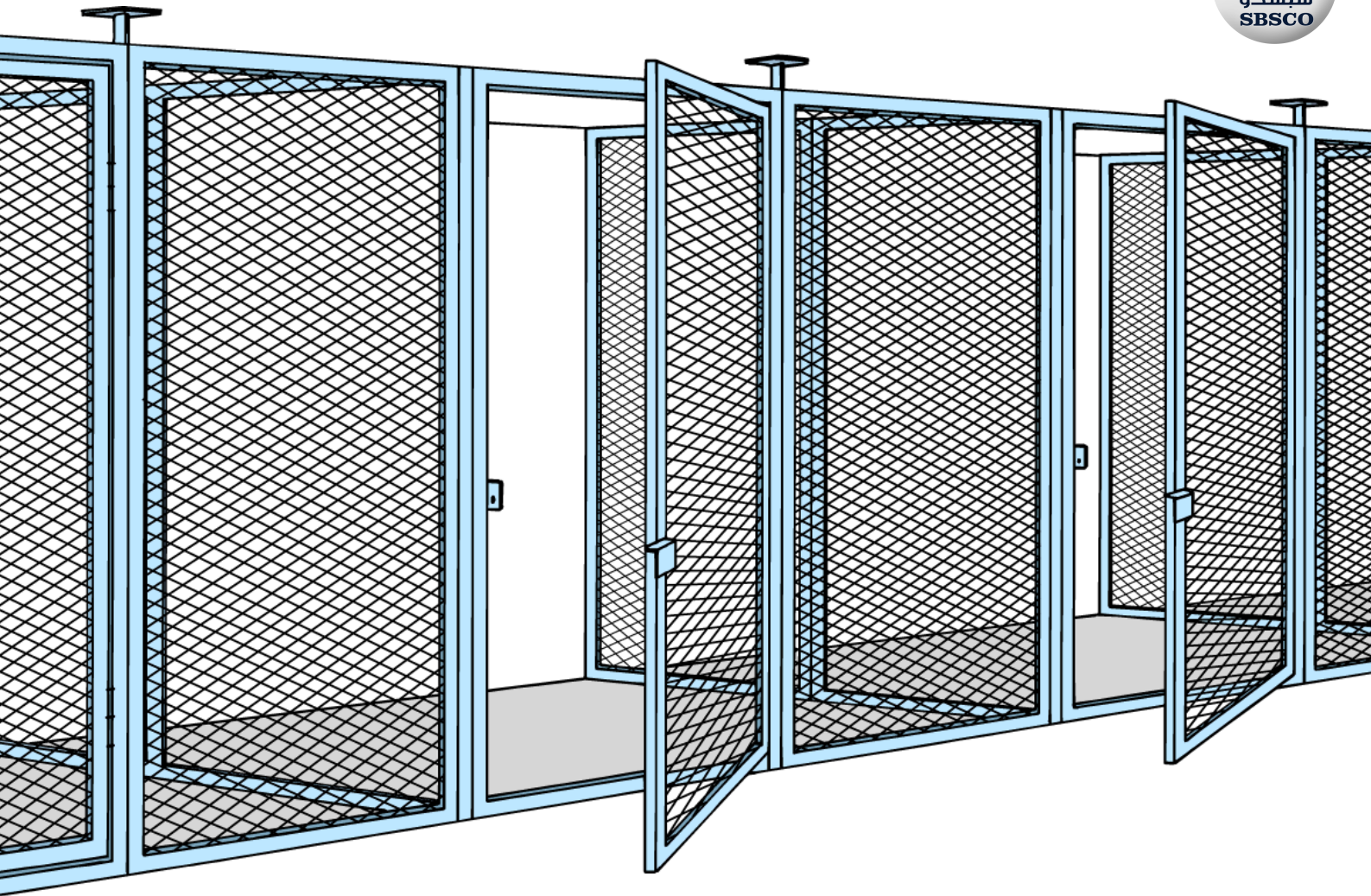

Mesh Dimensions

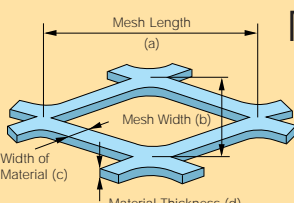

Mesh Size (a x b) 115 x 44 mm
 Width of material 3,0 mm
 Material Thickness (d) 2,5 mm

Also other dimensions can be used.

Wall Sections

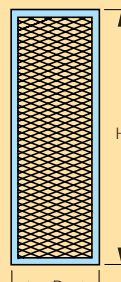

Self-supporting wall sections in sizes indicated in the table are in stock. Other sizes to requirement.

H x B = 2.250 x 200	H x B = 2.250 x 1.000
H x B = 2.250 x 300	H x B = 2.250 x 1.200
H x B = 2.250 x 400	H x B = 2.250 x 1.530
H x B = 2.250 x 600	

Lock

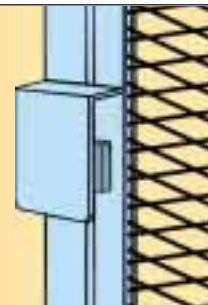

Each door is provided with a stable lock fitting and an approved padlock.

Door Sections

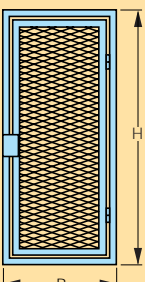

The doors sections consist of a strong frame with hinge and lock fittings. The construction corresponds to that of the wall sections.

H x B = 2.250 x 900 (Door 1.980 x 800 mm)

Anchoring Plates

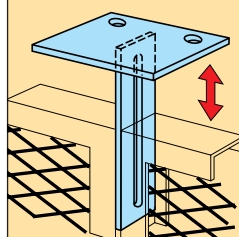

The expanded metal sections are anchored in ceiling and floor by means of height adjustable anchoring plates.

BUILDING FENCES

Module type fence suitable for building sites, temporary barred areas, crowd control barriers etc. The sections are self-supporting and are easily mounted with loose adjustable support legs. The sections are connected to each other by bolting. Doors and gates are manufactured to requirement. As standard all material is hot dip galvanized.

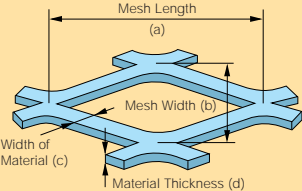

Mesh Dimensions

Mesh Size (a x b)	115 x 44 mm
Width of Material (c):	3,0 mm
Material Thickness (d):	2,5 mm

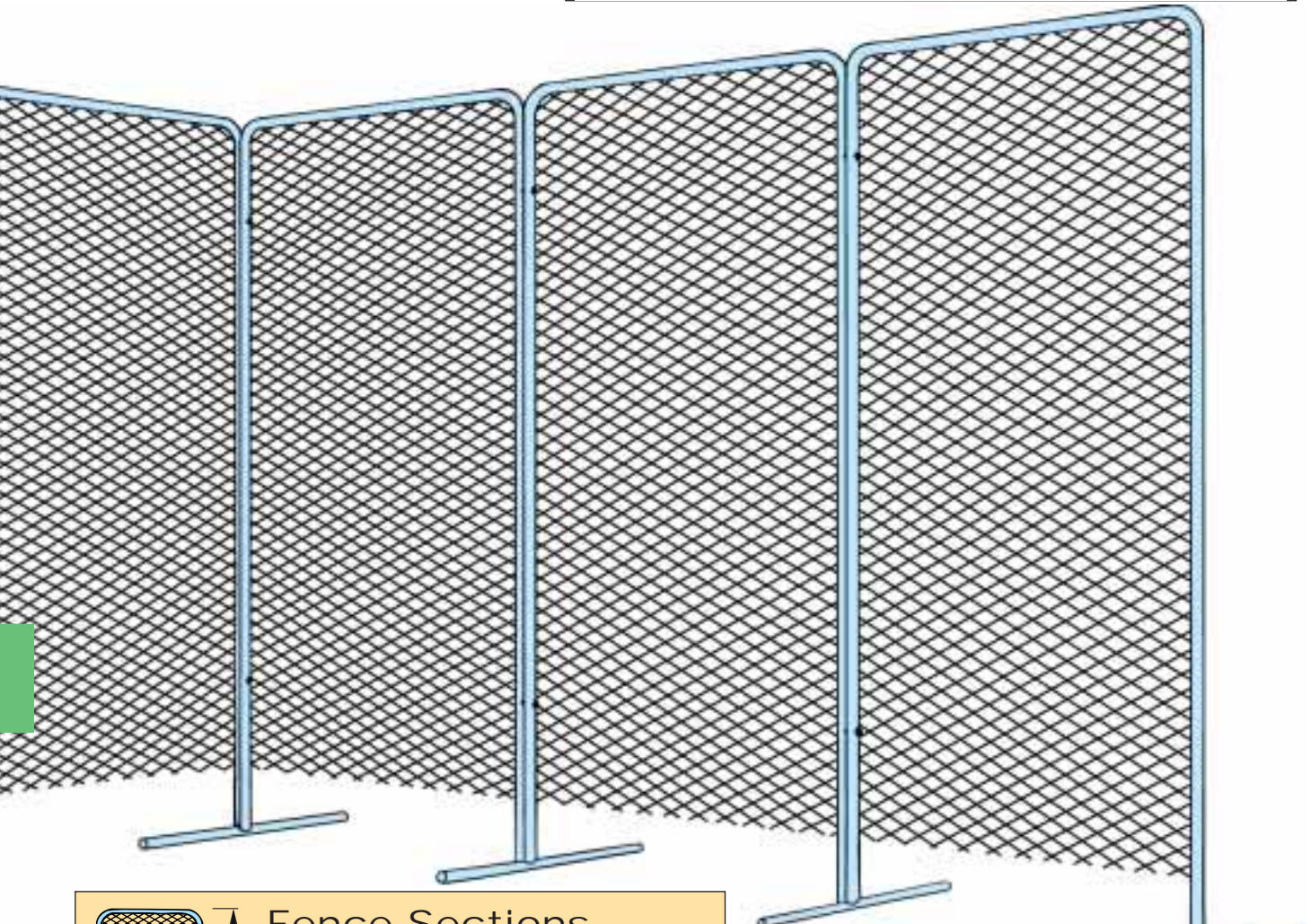
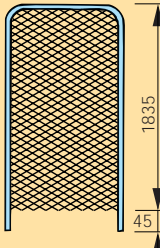
Fence Sections

Self-supporting fence sections are stocked with width 1530 mm and height 1880 mm. The sections are connected to each other by means of bolting.



Support Legs

Hot dip galvanized support legs of bended tube for easy and stable mounting.

DOG KENNELS

Dog Kennels are constructed of sections of expanded metal with a strong self-supporting frame, supplied from stock.

Door sections are also supplied from stock. The system is very flexible, and the sections are easily mounted.

Sections in sizes other than standard are manufactured to customer requirement.

All material is hot dip galvanized.

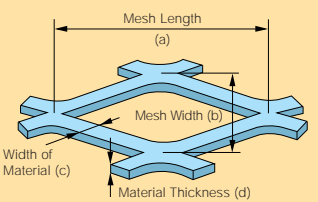
Mesh Dimensions

Mesh Size (a x b)	115 x 44 mm
Width of Material (c):	3,0 mm
Material Thickness (d):	2,5 mm

Also other dimensions can be used.



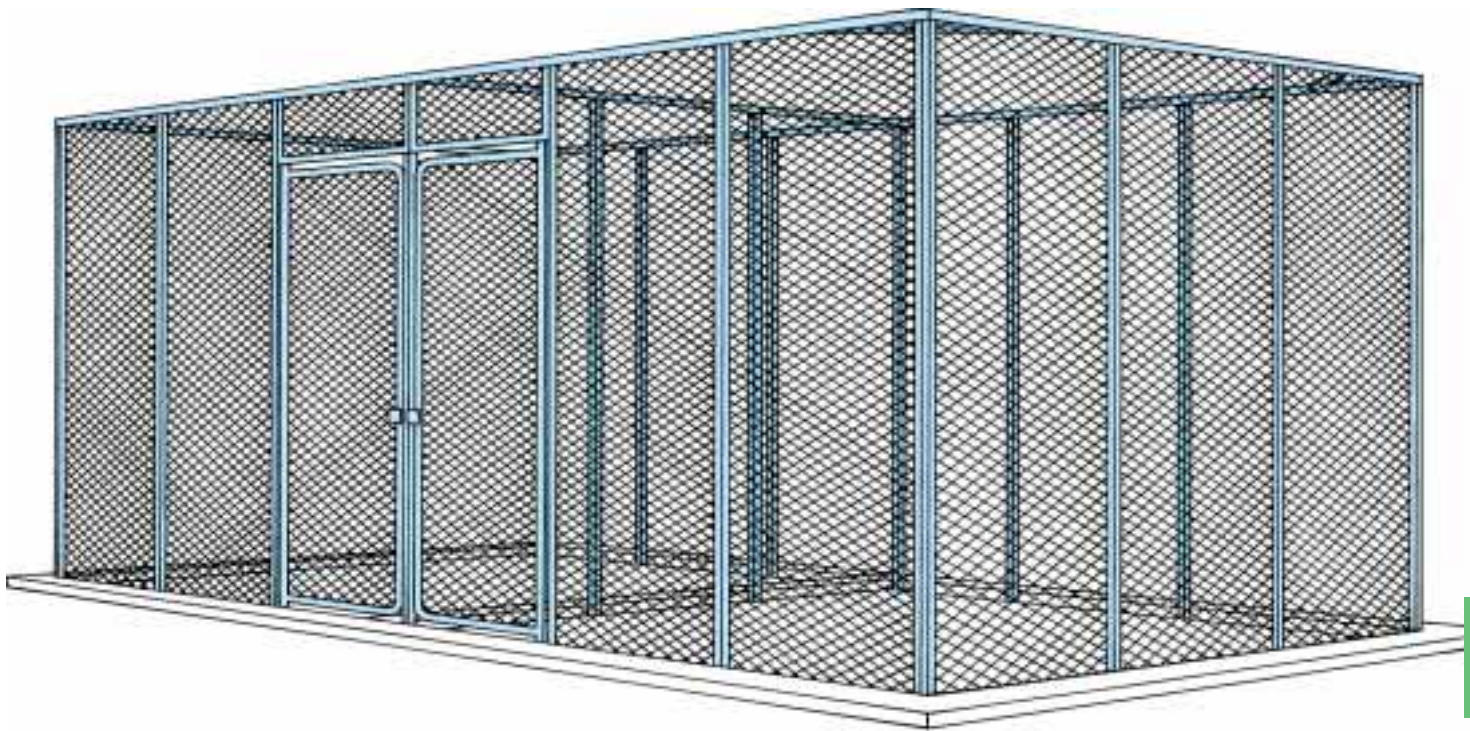
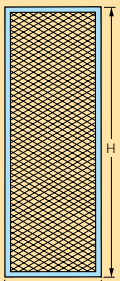

Wall Sections

Self-supporting wall sections, stocked in sizes indicated in the table. Other sizes on customer requirement.

H x B =	2.250 x 600
H x B =	2.250 x 1.530

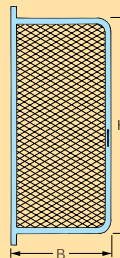
Mounting kit included



Door Sections

The door consists of a strong frame of tube and is supplied with lock fittings. Stock size

H x B = 2.250 x 930 mm

ALABUO GROUP

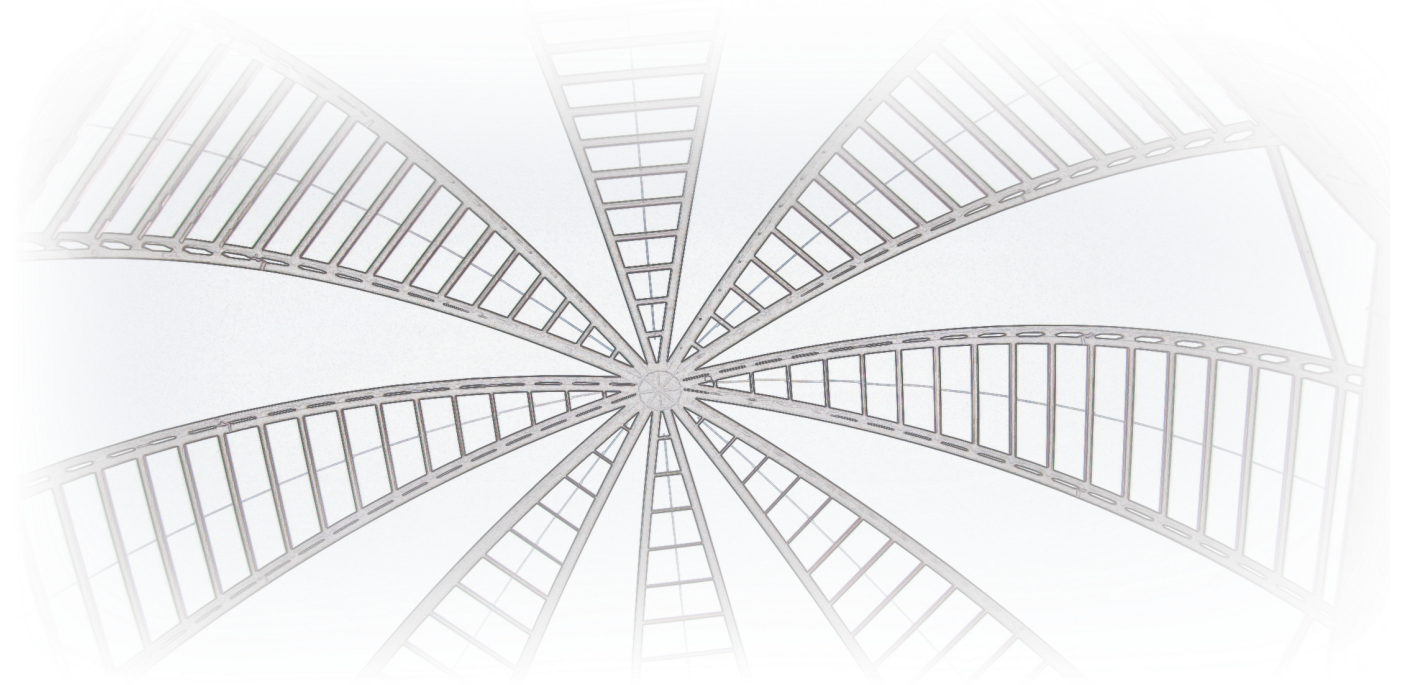

أكافي الصناعي
AKAFI.NET



شركة المشغولات والمباني المعدنية المحدودة
Steel Building & Structure Co. Ltd.



شركة الخيام والمظلات المحدودة
TENTS & AWNING CO. LTD.



شركة الشهباء للإنشاءات المحدودة
AL-Shahba For Construction Co. Ltd.

www.alabuo.com



شركة المشغولات والمباني المعدنية المحدودة
Steel Building & Structure Co. Ltd.



CERT
04000257
Cert. No. 3109092031

kingdom Of Saudi Arabia Dammam City

Second Industrial Area - Street 85 - Building No. 7083

Zip Code 34331-4199

www.alabuo.co

Tel : +966 13 838 3311

fax : +966 13 838 3322

alabuo@alabuo.co